

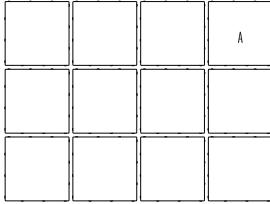

INDUSTRIA 300 SERIES

DESCRIPTION: Paver **TEXTURE:** HD² Smooth or HD² Granitex

PALLET OVERVIEW - 300x300



PALLET OVERVIEW - TRIANGLE

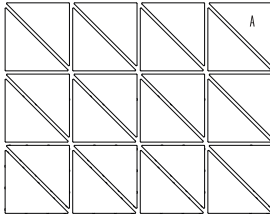

NOTES

See page 60 to 62 for more technical information.

See page 29 for more information about applications.

300 Series HD² Polished and HD² Granitex is made-to-order, minimum order of 500 sq. ft. Deposit required. HD² Smooth is in stock with shorter lead times.

Specifications per pallet		Imperial	Metric
300x300	Cubing	81.38 ft²	7.56 m ²
	Approx. Weight	3 725 lbs	1 690 kg
	Number of rows	7	
	Coverage per row	11.63 ft ²	1.08 m ²
	Linear coverage per row	11.81 lin. ft	3.60 lin. m

Unit dimensions		in	mm	Units/pallet
	Height	3 15/16	100	84 units
	Width	11 13/16	300	
	Length	11 13/16	300	

Specifications per pallet		Imperial	Metric
TRIANGLE	Cubing	81.38 ft²	7.56 m ²
	Approx. Weight	3 743 lbs	1 698 kg
	Number of rows	7	
	Coverage per row	11.63 ft ²	1.08 m ²
	Linear coverage per row	11.81 lin. ft	3.60 lin. m

Unit dimensions		in	mm	Units/pallet
	Height	3 15/16	100	168 units
	Width	11 13/16	300	
	Length	11 13/16	300	

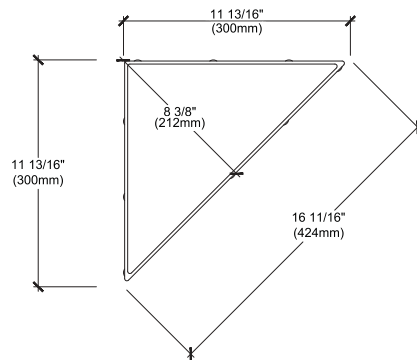

01 | Linear pattern

100% - 300x300

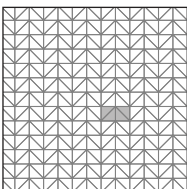

03 | Linear pattern

100% - 300x300

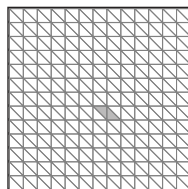

Patterns are for design inspiration only. The installer is responsible to calculate & purchase the correct amount of material.

Chestnut Brown

HD² Smooth
HD² Granitex



Beige Cream

HD² Smooth
HD² Granitex

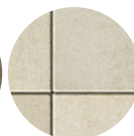

Greyed Nickel

HD² Smooth
HD² Granitex

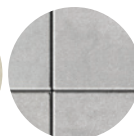

Shale Grey

HD² Smooth
HD² Granitex

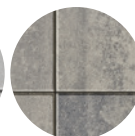

Onyx Black

HD² Smooth
HD² Granitex

